

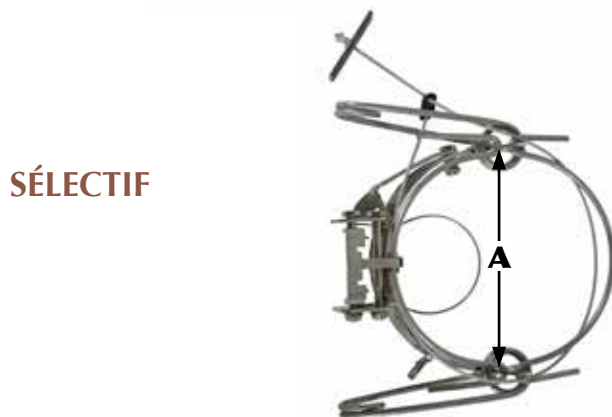

Certified trap identification sheet

BELISLE FOOTSNARE

JUNE 1, 2018

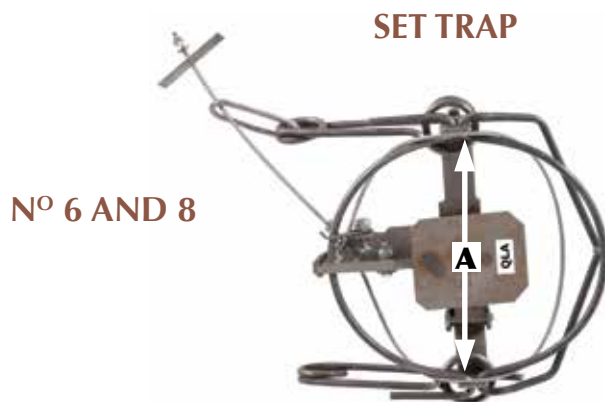

AIHTS CERTIFICATION

MODEL	NUMBER	TARGET SPECIES	INSIDE MEASUREMENT (A) TAKEN ON THE SET TRAP
N° 6	QLA	Canada Lynx, Coyote, Bobcat, Red fox	5 ³ / ₄ inch (148 mm)
N° 8	QWA	Wolf	7 ³ / ₄ inch (197 mm)
SÉLECTIF	QYB	Canada Lynx, Coyote, Bobcat, Red fox	5 ³ / ₄ inch (148 mm)

Certified trap identification sheet

JUNE 1, 2018

Commercial name of trap :
BELISLE FOOTSNARE



LOCATION OF THE
CERTIFICATION NUMBER



Certified trap identification sheet

BRIDGER ALASKAN NO 5

JUNE 1, 2018



OFFSET, LAMINATED



RUBBER JAWS



MODEL	AIHTS CERTIFICATION		INSIDE MEASUREMENT TAKEN ON THE SET TRAP	
	NUMBER	TARGET SPECIES	(A)	(B)
OFFSET, LAMINATED	QWE	Wolf	7 inch (176 mm)	7 1/8 inch (180 mm)
RUBBER JAWS	QWF	Wolf	6 7/8 inch (175 mm)	6 7/8 inch (175 mm)



Certified trap identification sheet

BRIDGER BRAWN

JUNE 1, 2018



MODEL	AIHTS CERTIFICATION		INSIDE MEASUREMENT TAKEN ON THE SET TRAP	
	NUMBER	TARGET SPECIES	(A)	(B)
N° 9 RUBBER JAWS	AWA	Wolf	7 1/2 inch (190 mm)	8 1/16 inch (205 mm)



Certified trap identification sheet

BRIDGER "COIL SPRINGS" OFFSET + LAMINATED JAWS

JUNE 1, 2018

SET TRAP

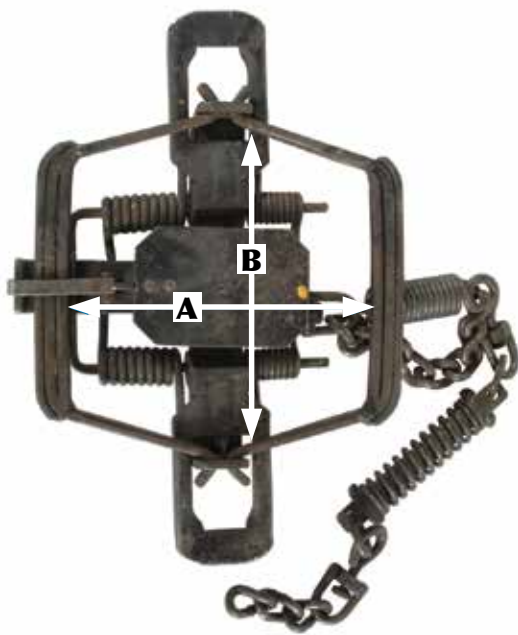

CLOSED TRAP

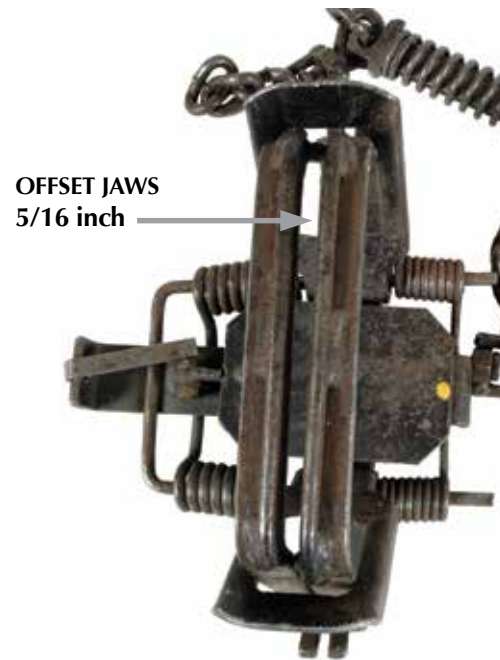

SEE REVERSE FOR MORE COMPONENTS DETAILS

MODEL	AIHTS CERTIFICATION		INSIDE MEASUREMENT TAKEN ON THE SET TRAP	
	NUMBER	TARGET SPECIES	(A)	(B)
N° 3 4 SPRINGS	VYB	Coyote	5 ³ / ₄ inch (146 mm)	5 ⁷ / ₁₆ inch (138 mm)

Commercial name of trap :

**BRIDGER "COIL SPRINGS"
OFFSET + LAMINATED JAWS**



ROUNDED LAMINATIONS

ON TOP END
OF JAW 3/16 inch

ON UNDERSIDE
OF JAW 1/4 po inch

JAW



**ANCHORING SWIVEL CENTRE
(MOUNTED ON A BASE PLATE)**



Certified trap identification sheet

BRIDGER "T3"

JUNE 1, 2018

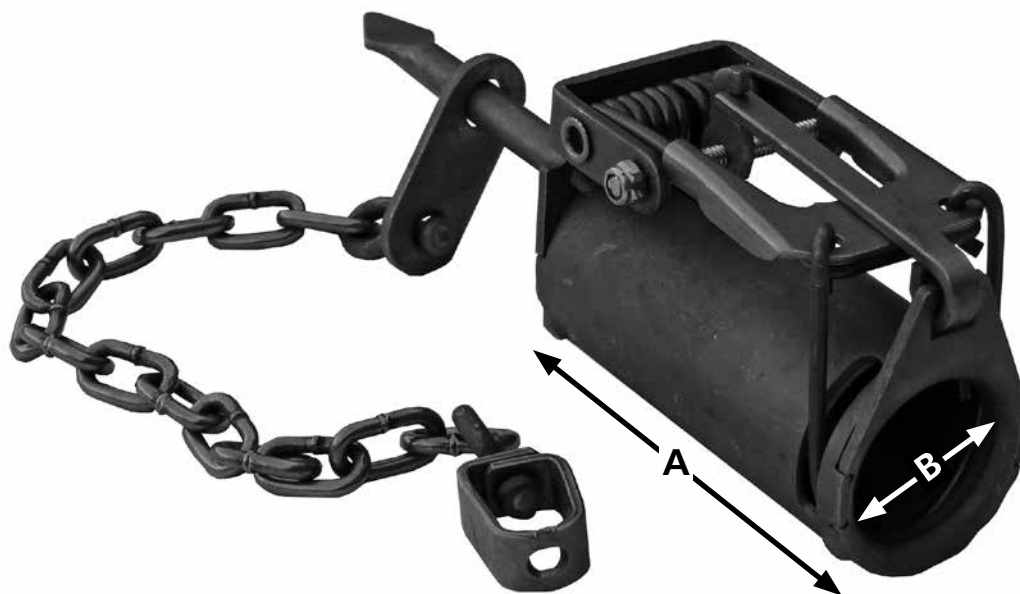

MODEL	AIHTS CERTIFICATION		MEASUREMENTS	
	NUMBER	TARGET SPECIES	(A)	(B)
T3	VRB	Raccoon	4 inch (100 mm)	1 1/4 inch (30 mm)



Certified trap identification sheet

COMSTOCK

JUNE 1, 2018

SET TRAP



CLOSED TRAP

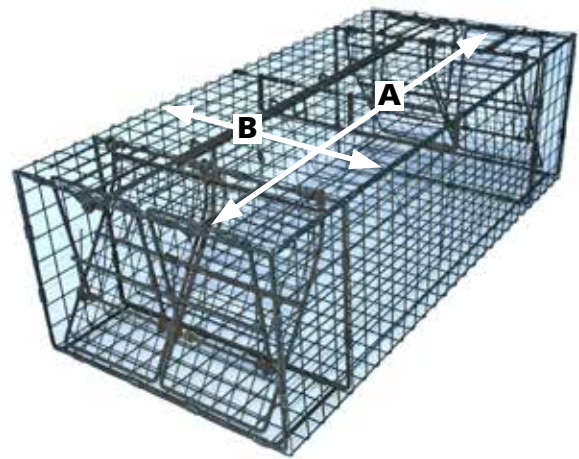

MODEL	AIHTS CERTIFICATION		MEASUREMENTS	
	NUMBER	TARGET SPECIES	(A)	(B)
12x18x39 SWIM THROUGH BEAVER CAGE	VCC	Beaver	39 inch (99 cm)	12 inch (30 cm)



Certified trap identification sheet

DUFFER

JUNE 1, 2018

SET TRAP



AIHTS CERTIFICATION

MODEL	NUMBER	TARGET SPECIES	WIDTH (A)
RACCOON TRAP	ORH	Raccoon	2 1/2 inch (60 mm)



Certified trap identification sheet

DUKE

JUNE 1, 2018

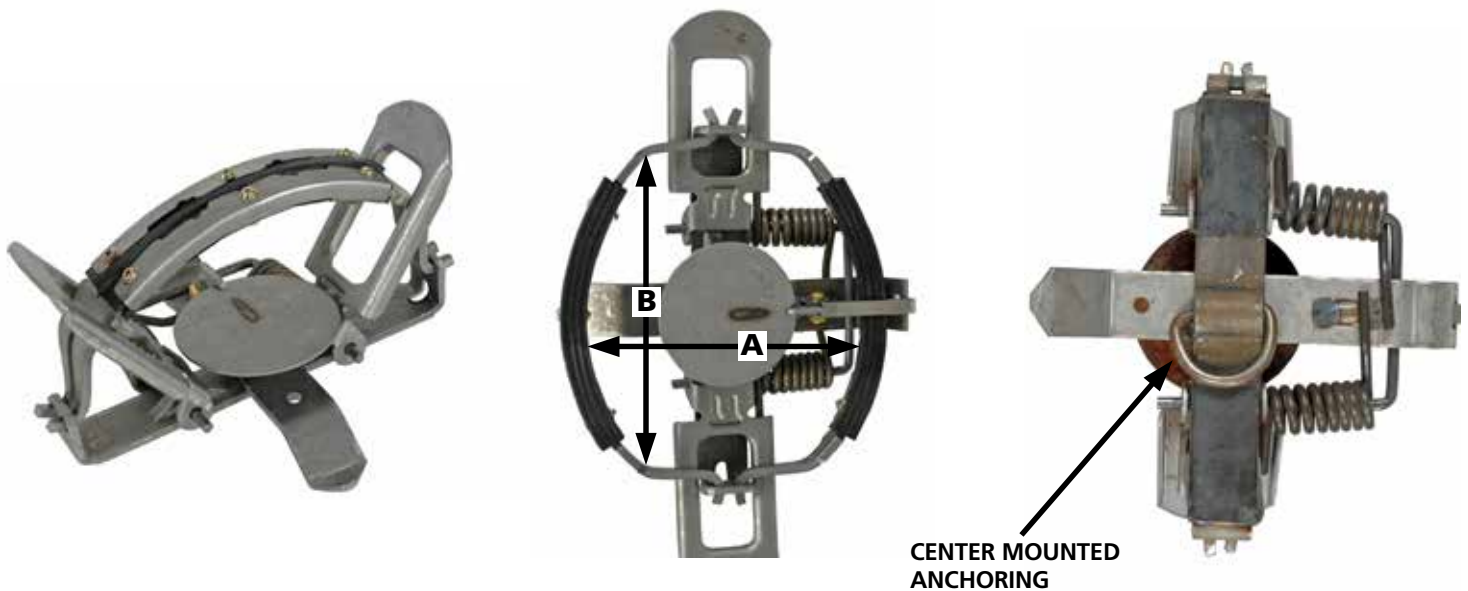

MODEL	AIHTS CERTIFICATION		INSIDE MEASUREMENT TAKEN ON THE SET TRAP	
	NUMBER	TARGET SPECIES	(A)	(B)
N° 3 RUBBER JAWS 2 SPRINGS	VYC	Coyote	5 inch (127 mm)	5 ⁷ / ₈ inch (150 mm)



Certified trap identification sheet

DUKE DP

JUNE 1, 2018

CLOSED TRAP



AIHTS CERTIFICATION			
MODEL	NUMBER	TARGET SPECIES	WIDTH (A)
DUKE DP COON TRAP	QRX	Raccoon	1 1/4 inch (30 mm)



Certified trap identification sheet

EGG TRAP

JUNE 1, 2018

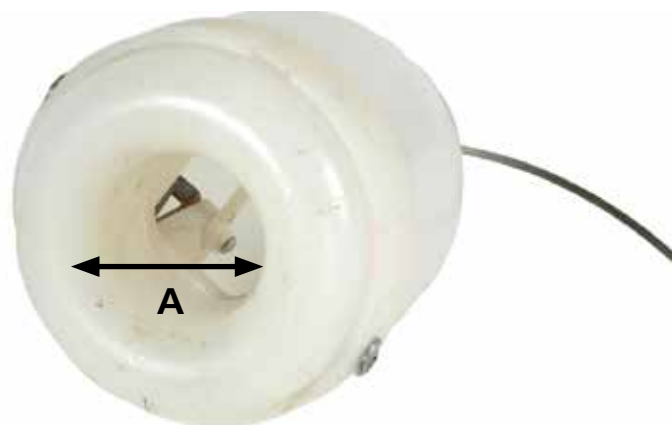

AIHTS CERTIFICATION

MODEL	NUMBER	TARGET SPECIES	(A)
EGG TRAP	VR1	Raccoon	1 1/2 inch (38 mm)



Certified trap identification sheet

EZEE SET

JUNE 1, 2018

SET TRAP



CLOSED TRAP

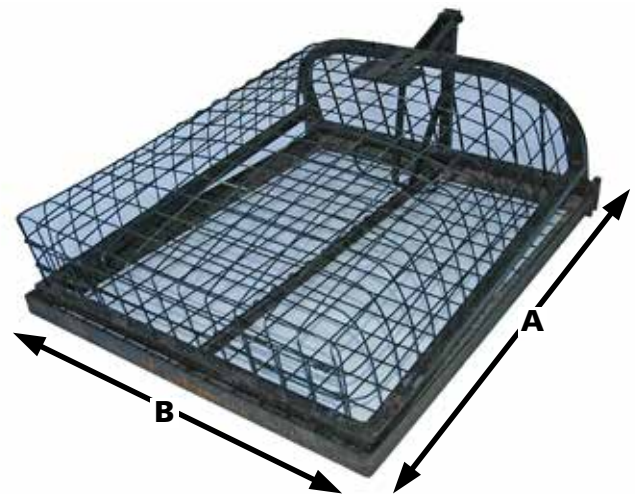

MODEL	AIHTS CERTIFICATION		MEASUREMENTS	
	NUMBER	TARGET SPECIES	(A)	(B)
EZEE SET LIVE BEAVER TRAP	VCA	Beaver	35 inch (89 cm)	28 inch (71 cm)



Certified trap identification sheet

JUNE 1, 2018

KORO "KLAM"

SET TRAP

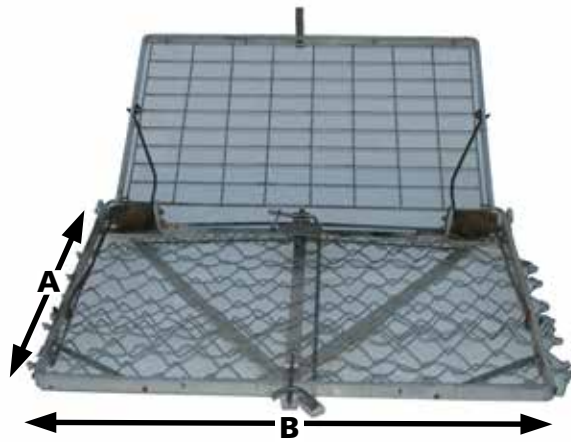

CLOSED TRAP



MODEL	AIHTS CERTIFICATION		MEASUREMENTS	
	NUMBER	TARGET SPECIES	(A)	(B)
KORO «KLAM» LIVE BEAVER TRAP	VCB	Beaver	19 1/2 inch (49.4 cm)	32 1/4 inch (82 cm)



Certified trap identification sheet

LIL' GRIZZ GETRZ

JUNE 1, 2018

SET TRAP



AIHTS CERTIFICATION			
MODEL	NUMBER	TARGET SPECIES	WIDTH (A)
LIL' GRIZZ GETRZ	ORI	Raccoon	1 1/4 inch (30 mm)



Certified trap identification sheet

LIVESTOCK PROTECTION

JUNE 1, 2018

SET TRAP

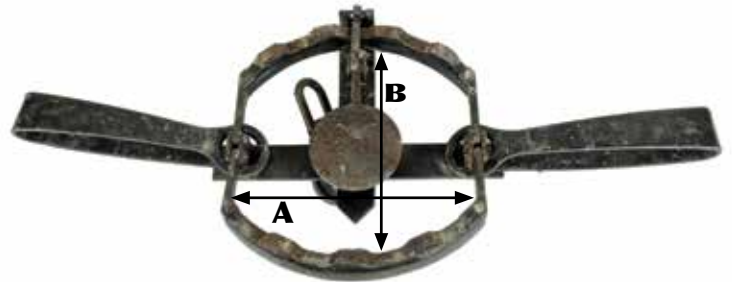

MODEL	AIHTS CERTIFICATION		INSIDE MEASUREMENT TAKEN ON THE SET TRAP	
	NUMBER	TARGET SPECIES	(A)	(B)
EZ GRIP N° 7	QWC	Wolf	6 inch (152 mm)	6 1/4 inch (160 mm)



Certified trap identification sheet

MB

JUNE 1, 2018

**750
ALASKAN OS ^{3/8"}**



**550 4CS
RUBBER
JAWS**

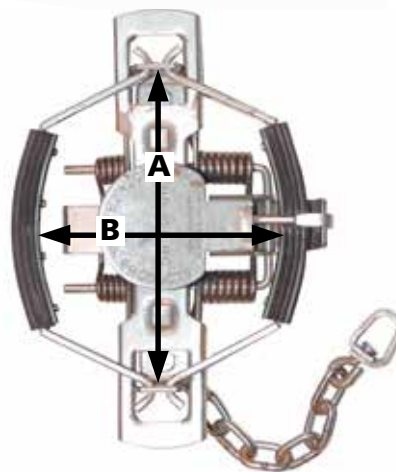

MODEL	AIHTS CERTIFICATION		INSIDE MEASUREMENT TAKEN ON THE SET TRAP	
	NUMBER	TARGET SPECIES	(A)	(B)
ALASKAN OS ^{3/8"}	QWG	Wolf	7 ^{1/4} inch (184 mm)	7 inch (180 mm)
550 4CS RUBBER JAWS	AYA	Coyote	6 ^{1/4} inch (158 mm)	4 ^{3/4} inch (121 mm)



Certified trap identification sheet

ONEIDA VICTOR "COIL SPRINGS" OFFSET + LAMINATED JAWS

JUNE 1, 2018

SET TRAP

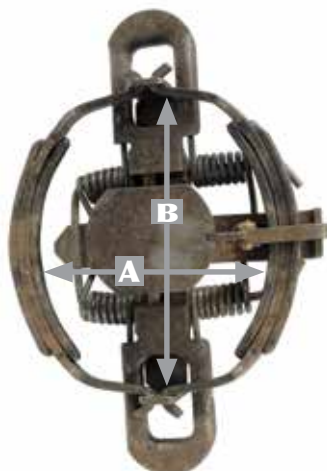

CLOSED TRAPS



4 SPRINGS



2 SPRINGS

SEE REVERSE FOR MORE COMPONENTS DETAILS

MODEL	AIHTS CERTIFICATION		INSIDE MEASUREMENT TAKEN ON THE SET TRAP	
	NUMBER	TARGET SPECIES	(A)	(B)
N° 1.75 2 SPRINGS	VDB	Bobcat	4 1/2 inch (115 mm)	4 5/8 inch (118 mm)
N° 1.75 4 SPRINGS	QYC	Coyote	4 1/2 inch (115 mm)	4 5/8 inch (118 mm)
N° 3 2 SPRINGS	QYE	Coyote, Bobcat	4 3/4 inch (121 mm)	6 inch (153 mm)
N° 3 4 SPRINGS	QYD	Coyote	4 3/4 inch (121 mm)	6 inch (153 mm)

Commercial name of trap :
**ONEIDA VICTOR "COIL SPRINGS"
OFFSET + LAMINATED JAWS**

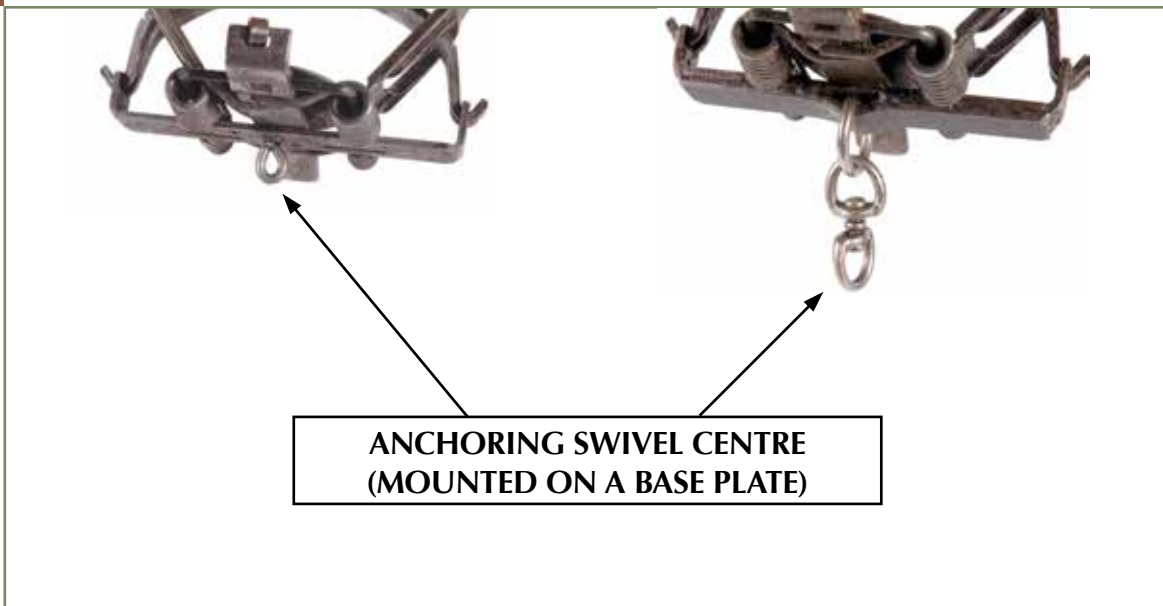
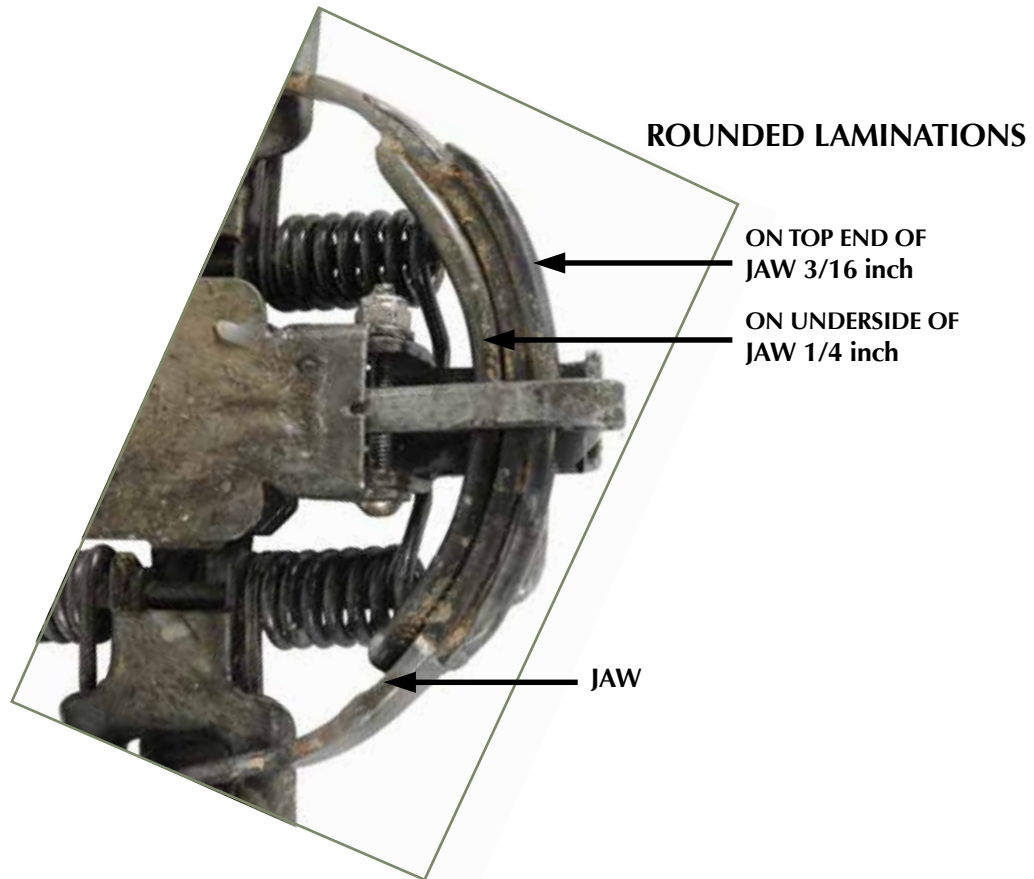



Certified trap identification sheet

ONEIDA VICTOR "COIL SPRINGS" NO 3 NON-OFFSET + LAMINATED JAWS

JUNE 1, 2018

SET TRAP

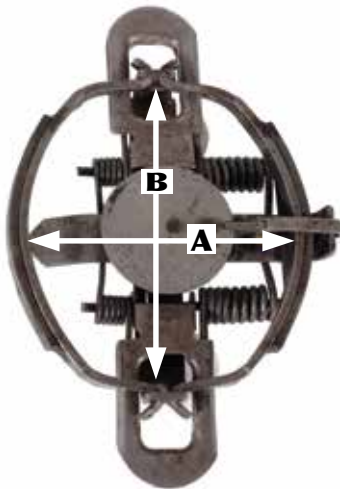

CLOSED TRAP

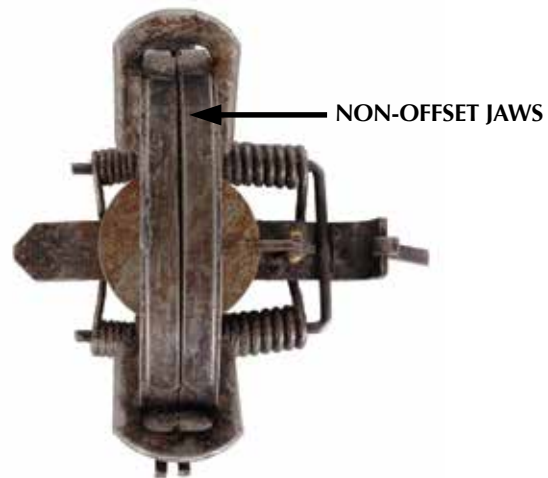

SEE REVERSE FOR MORE COMPONENTS DETAILS

MODEL	AIHTS CERTIFICATION		INSIDE MEASUREMENT TAKEN ON THE SET TRAP	
	NUMBER	TARGET SPECIES	(A)	(B)
N° 3 4 SPRINGS	QLC	Canada Lynx	5 1/4 inch (133 mm)	6 inch (153 mm)

Commercial name of trap :

**ONEIDA VICTOR "COIL SPRINGS"
NO 3
NON-OFFSET + LAMINATED JAWS**

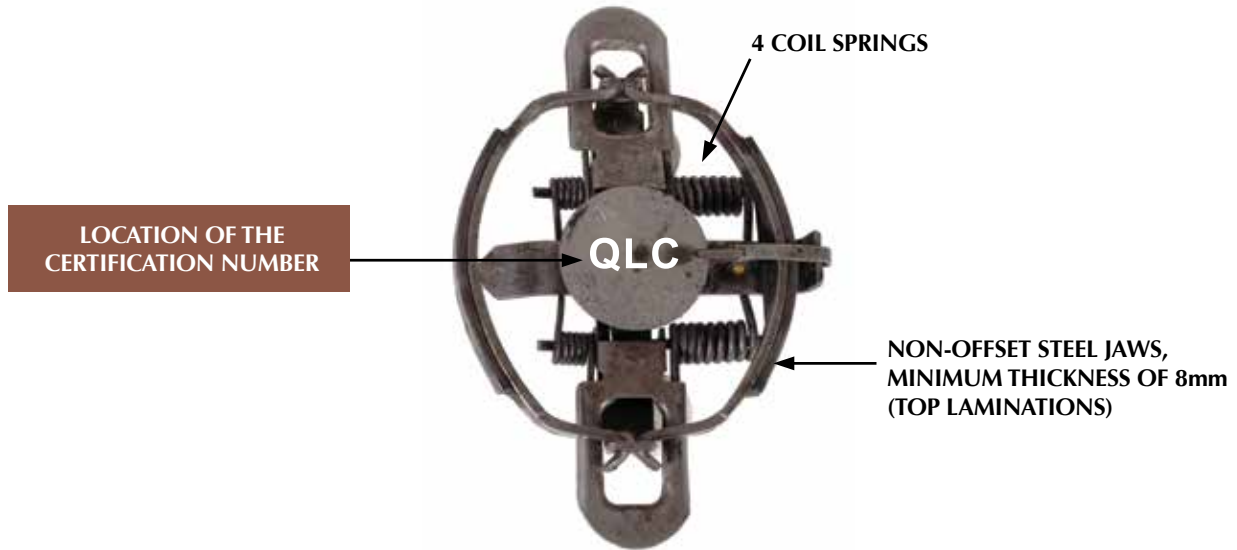

CHARACTERISTICS

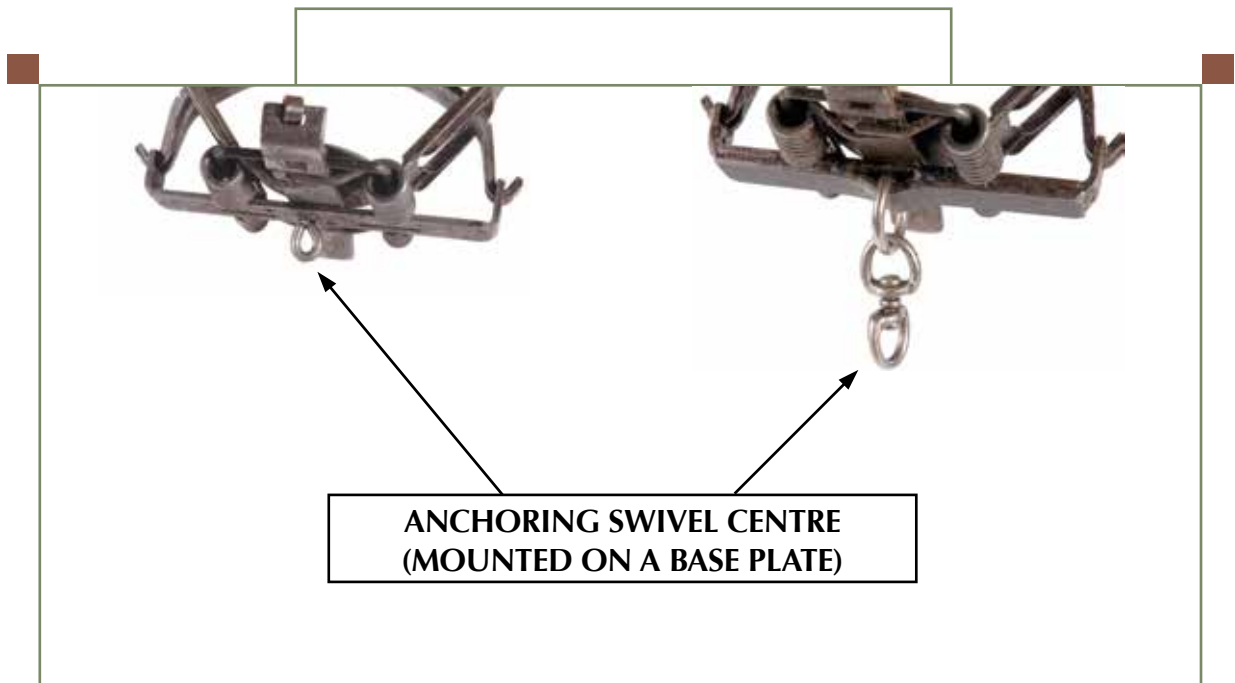



Certified trap identification sheet

ONEIDA VICTOR "SOFT CATCH"

JUNE 1, 2018

SET TRAP

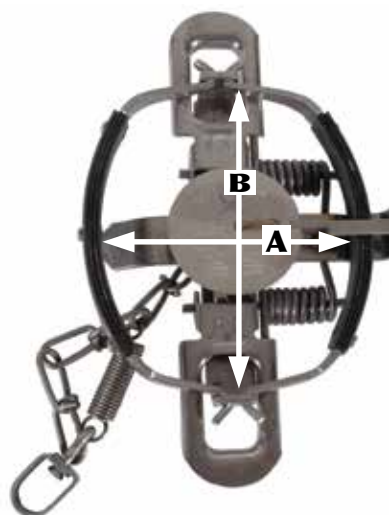

CLOSED TRAP



4 SPRINGS



2 SPRINGS

MODEL	AIHTS CERTIFICATION		INSIDE MEASUREMENT TAKEN ON THE SET TRAP	
	NUMBER	TARGET SPECIES	(A)	(B)
N° 1.5 2 SPRINGS	VYA	Coyote	4 ⁵ / ₈ inch (120 mm)	4 ⁵ / ₈ inch (120 mm)
N° 1.5 4 SPRINGS	VDA	Coyote, Bobcat	4 ⁵ / ₈ inch (120 mm)	4 ⁵ / ₈ inch (120 mm)
N° 3 2 SPRINGS	QY1	Canada Lynx, Coyote, Bobcat	5 inch (127 mm)	6 ¹ / ₈ inch (156 mm)
N° 3 4 SPRINGS	QLB	Canada Lynx, Bobcat, Coyote	5 inch (127 mm)	6 ¹ / ₈ inch (156 mm)

Commercial name of trap :
ONEIDA VICTOR
"SOFT CATCH"

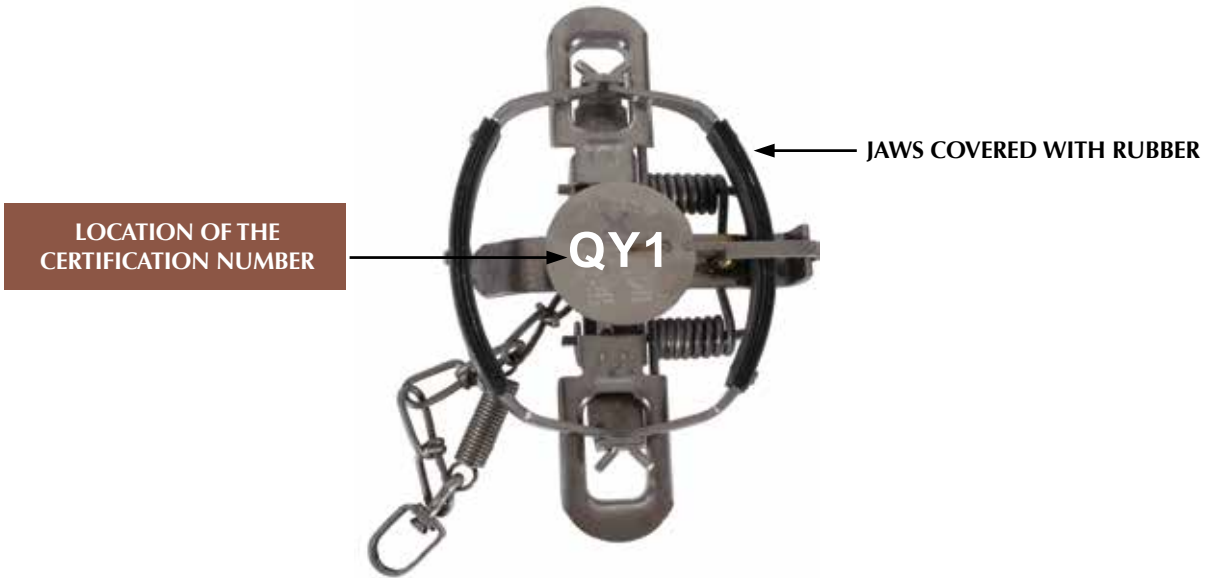

CHARACTERISTICS

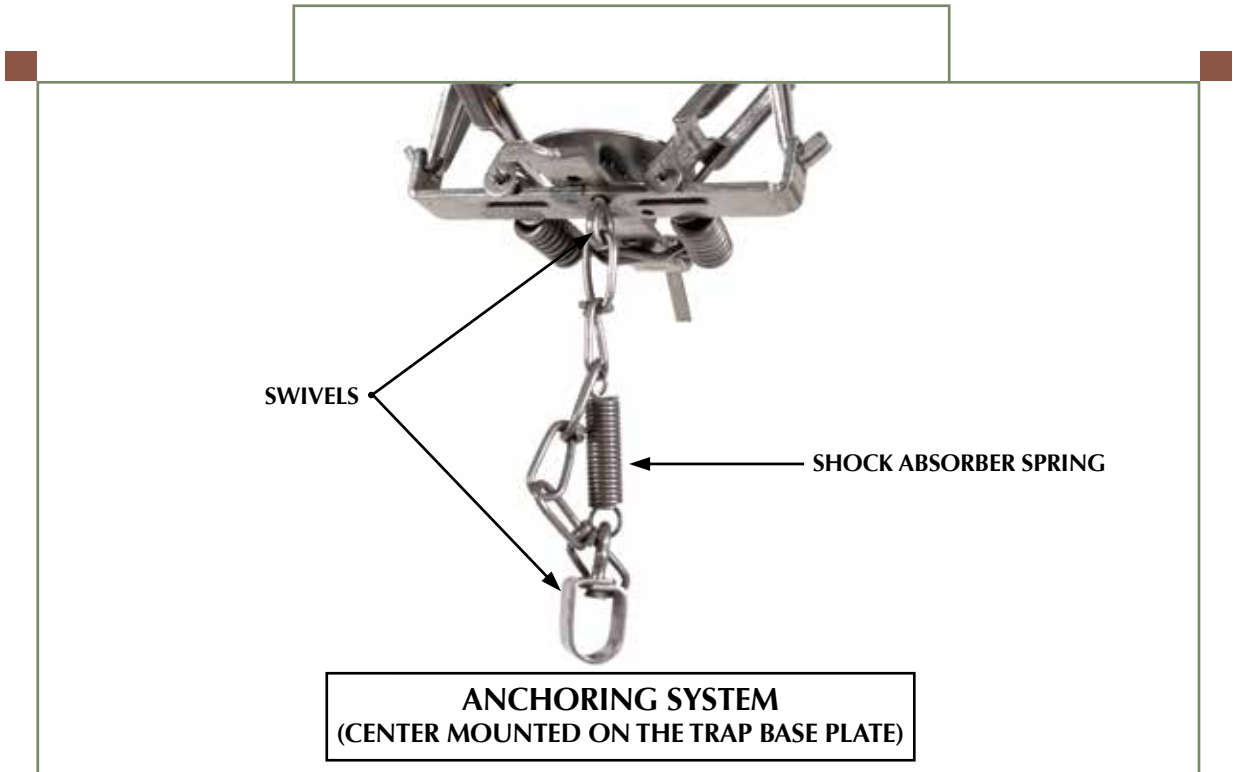



Certified trap identification sheet

ONEIDA VICTOR "SOFT CATCH" NO 3 (MODIFIED FOR WOLF)

JUNE 1, 2018

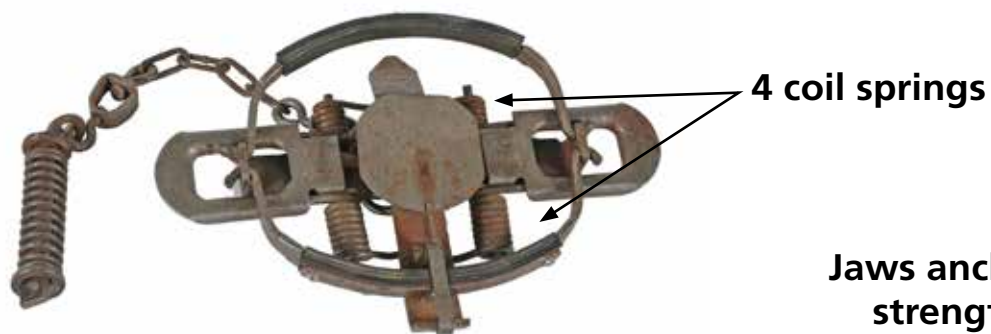

Jaws anchoring point strengthened by welding points

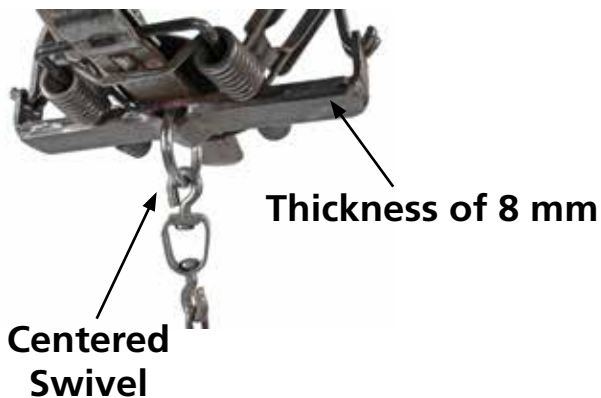

AIHTS CERTIFICATION

MODEL	NUMBER	TARGET SPECIES	CHARACTERISTICS
3 SC (MODIFIED)	QWB	Wolf	<ul style="list-style-type: none"> • 4 coil springs • Minimum 8 mm thick base plate • Centered swivel



Certified trap identification sheet

RUDY RED WOLF

JUNE 1, 2018



MODEL	AIHTS CERTIFICATION		INSIDE MEASUREMENT TAKEN ON THE SET TRAP	
	NUMBER	TARGET SPECIES	(A)	(B)
N° 4 1/2	QWD	Wolf	6 3/8 inch (162 mm)	7 3/8 inch (185 mm)